

## Repositório ISCTE-IUL

---

Deposited in *Repositório ISCTE-IUL*:

2022-11-29

Deposited version:

Accepted Version

Peer-review status of attached file:

Peer-reviewed

Citation for published item:

Pinheiro, B. R., Rebola, J. L. & Cartaxo, A. V. T. (2016). Tolerance to in-band crosstalk of virtual carrier-assisted direct detection multi-band OFDM system. In Ribeiro, P. A., e Raposo, M. (Ed.), Proceedings of the 4th International Conference on Photonics, Optics and Laser Technology - PHOTOPTICS. (pp. 33-39). Roma: SciTePress.

Further information on publisher's website:

10.5220/0005743300310037

Publisher's copyright statement:

This is the peer reviewed version of the following article: Pinheiro, B. R., Rebola, J. L. & Cartaxo, A. V. T. (2016). Tolerance to in-band crosstalk of virtual carrier-assisted direct detection multi-band OFDM system. In Ribeiro, P. A., e Raposo, M. (Ed.), Proceedings of the 4th International Conference on Photonics, Optics and Laser Technology - PHOTOPTICS. (pp. 33-39). Roma: SciTePress., which has been published in final form at <https://dx.doi.org/10.5220/0005743300310037>. This article may be used for non-commercial purposes in accordance with the Publisher's Terms and Conditions for self-archiving.

---

### Use policy

Creative Commons CC BY 4.0

The full-text may be used and/or reproduced, and given to third parties in any format or medium, without prior permission or charge, for personal research or study, educational, or not-for-profit purposes provided that:

- a full bibliographic reference is made to the original source
- a link is made to the metadata record in the Repository
- the full-text is not changed in any way

The full-text must not be sold in any format or medium without the formal permission of the copyright holders.

---

# Tolerance to In-Band Crosstalk of Virtual Carrier-Assisted Direct Detection Multi-Band OFDM Systems

Bruno R. Pinheiro<sup>1</sup>, João L. Rebola<sup>1,2</sup> and Adolfo V. T. Cartaxo<sup>1,3</sup>

<sup>1</sup>*Optical Communications and Photonics, Instituto de Telecomunicações, Lisboa, Portugal*

<sup>2</sup>*Instituto Universitário de Lisboa (ISCTE-IUL), Lisboa, Portugal*

<sup>3</sup>*Instituto Superior Técnico, Universidade de Lisboa, Lisboa, Portugal*  
{bruno\_pinheiro, joao.rebola}@iscte.pt, adolfo.cartaxo@lx.it.pt

**Keywords:** Direct detection, in-band crosstalk, Monte-Carlo simulation, multi-band orthogonal frequency division multiplexing

**Abstract:** The tolerance to in-band crosstalk of virtual carrier (VC)-assisted direct detection (DD) multi-band orthogonal frequency division multiplexing (MB-OFDM) system is assessed numerically through Monte-Carlo simulation and considering a single interferer. The influence of the virtual carrier-to-band power ratio (VBPR) and the virtual carrier-to-band gap (VBG) of the interferer on the in-band tolerance is also studied. We show that, for interferers with the same VBG as the selected signal, the increase of the VBPR of the interferer leads to lower optical signal-to-noise ratio (OSNR) penalties. The increase of the VBG of the interferer with central frequency different from the selected signal also leads to lower OSNR penalties. When the central frequencies of the interferer and selected bands are the same, the variation VBG of the interferer can lead to 11 dB less tolerance to in-band crosstalk of the VC-assisted DD OFDM system.

## 1 INTRODUCTION

Metropolitan networks are responsible for the aggregation of different types of traffic and to provide a link between access and back-bone networks. Hence, these networks must present high flexibility, enabling scalability, dynamic reconfigurability and transparency (Alves, 2015). The virtual carrier (VC)-assisted direct detection (DD) multi-band orthogonal frequency-division multiplexing (MB-OFDM) network, proposed in (Alves, 2014), has been appointed as an efficient approach to provide such requirements to metro networks (Alves, 2015). This approach is called MORFEUS (Alves, 2014). The use of a VC close to each OFDM band enhances the spectral efficiency (SE) and allows the reduction of the required receiver bandwidth (Peng, 2009).

An important limitation of DD OFDM systems is the signal-to-signal beat interference (SSBI) caused by photodetection. In this work, the SSBI mitigation technique presented in (Nezamalhosseini, 2013) is implemented, in order to eliminate the SSBI at the received OFDM signal. The use of the SSBI mitigation technique allows to reduce the band gap between the VC and the OFDM band, and consequently, the system SE is improved (Alves, 2014).

The metro networks performance can be impaired by in-band crosstalk. The in-band crosstalk is the interference between signals with same nominal wavelength, and it is originated from the imperfect isolation of the switching devices inside the optical nodes. This imperfect isolation induces power leakage from demultiplexed signals on the desired optical signal, known as crosstalk signals (Winzer, 2011). In-band crosstalk has been studied in the context of the conventional DD OFDM systems (Rebola, 2014), where the band gap between the VC and the OFDM band is equal to the OFDM signal. However, the performance of a VC-assisted DD OFDM system impaired by in-band crosstalk is still to be assessed.

In this work, the tolerance to in-band crosstalk of the VC-assisted DD MB-OFDM system is estimated through Monte-Carlo (MC) simulation and using the direct error counting (DEC) as bit error rate (BER) estimation method. The error vector magnitude (EVM) is also used as performance estimation method. We also evaluate the influence of the main parameters of the interferer on the DD OFDM system performance, such as the virtual carrier-to-band power ratio (VBPR) and virtual carrier-to-band gap (VBG) using the EVM and DEC methods, and the estimates are compared.

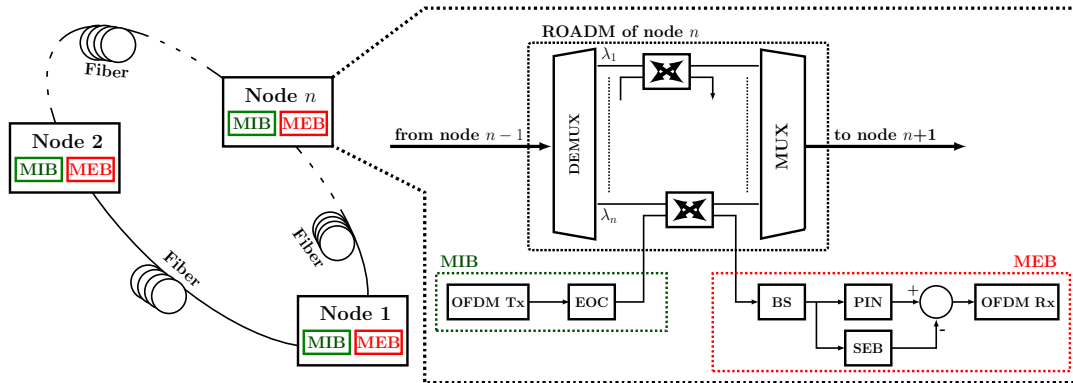

Figure 1: Block diagram of the MORFEUS metro network and respective nodes, comprising reconfigurable optical add-and-drop multiplexer (ROADM), MORFEUS insertion block (MIB) and MORFEUS extraction block (MEB). EOC, BS and SEB stand for electrical-optical converter, band selector and SSBI estimation block, respectively.

This paper is organized as follows. Section 2 describes the MORFEUS network and its simulation model. The MORFEUS network is presented in subsection 2.1 and, in subsection 2.2, the MC simulation is described. Numerical results are presented and discussed in Section 3. Conclusions are outlined in Section 4.

## 2 NETWORK MODEL

In this section, the MORFEUS network and its model are presented. Then, the main parameters of MB-OFDM signal are detailed. The MC simulation is also presented.

### 2.1 MORFEUS Network

Figure 1 depicts the block diagram of the MORFEUS metro network (Alves, 2015). The MORFEUS network consists of a ring topology. Each network node comprises a reconfigurable optical add-and-drop multiplexer (ROADM), a MORFEUS insertion block (MIB) and a MORFEUS extraction block (MEB). The MIB is responsible for the generation of the electrical OFDM bands and VCs at the OFDM transmitter (Tx). Then, the electrical OFDM signal is converted to the optical domain using an Electrical-to-Optical Converter (EOC), and inserted in the optical network (Alves, 2015). In the MEB, the band extraction is performed by a tunable optical filter (BS), which selects the desired OFDM signal. Then, the selected OFDM signal is sent to the SSBI estimation block (SEB) and also to the PIN photodiode in order to be photodetected. Then, the estimated SSBI obtained from the SEB, is removed from the photodetected OFDM signal, and after, the signal demodulation is performed at

the OFDM Rx.

The impact of in-band crosstalk on the DD OFDM receiver performance can be assessed considering a single OFDM band. Therefore, we assume that the OFDM signal has only one pair OFDM band-VC, whose spectrum is depicted in Figure 2.

Figure 2 depicts the OFDM signal at the output of the transmitter with an average power of 11 mW. The OFDM band has a bandwidth,  $B_w$ , of 2.675 GHz and a central frequency of 5 GHz. The bandwidth  $B_w$  is defined as  $N_{sc}/T_s$ , where  $N_{sc}$  is the number of the subcarriers and  $T_s$  is OFDM symbol duration without guard time. The frequency gap between the OFDM band and the VC is the VBG, which in Figure 2 is  $0.5B_w$ . In this work, in order to maximize the system SE, the VBG is set to 20.9 MHz. The ratio between the average power of the VC and the power of the corresponding OFDM band is the VBPR.

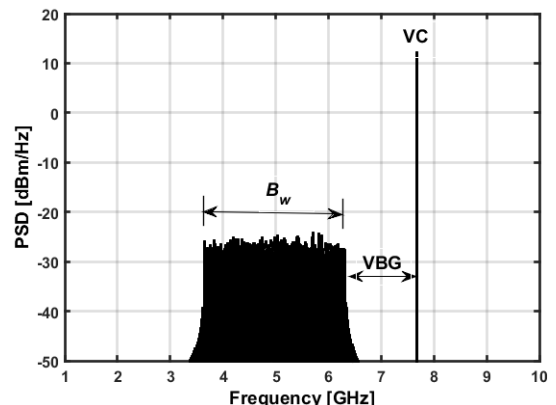

Figure 2: PSD of the electrical MB-OFDM signal at the OFDM Tx output, with an average power of 11 mW, considering one pair band-VC.

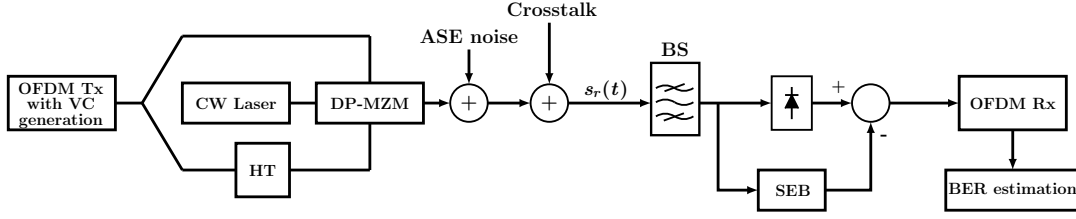

Figure 3: System model of the VC-assisted DD OFDM system. DP-MZM, HT and CW stand for dual parallel Mach-Zehnder modulator, Hilbert transform and continuous wave, respectively.

## 2.2 Monte Carlo Simulation

In this subsection, the MC simulation and the methods to assess the BER are described.

Figure 3 depicts the simulation model of the MORFEUS network considered to assess the tolerance of its performance to in-band crosstalk. It consists of an OFDM transmitter (Tx) with VC generation, a dual parallel Mach-Zehnder modulator (DP-MZM), a tunable band selector (BS), an ideal photodetector, a SEB and an OFDM receiver. The BER is estimated at the output of the OFDM receiver. Amplified spontaneous emission (ASE) noise and in-band crosstalk are added to the OFDM signal at the optical receiver input, before the BS.

The MC simulation starts with the generation of the electrical OFDM signal, comprising the OFDM band with a VC, and then, the electrical-optical conversion is performed by the DP-MZM. The DP-MZM generates a single-side band OFDM optical signal by applying the electrical OFDM signal and its Hilbert transform (HT) in the two arms of the modulator. In this work, the HT of the OFDM signal is considered ideal. The modulation index of the DP-MZM is set to the optimized value of 5% (Alves, 2015). Then, by assuming a back-to-back configuration, ASE noise and in-band crosstalk sample functions are added to the optical OFDM signal.

The model of the SEB is depicted in Figure 4, and it is based on the SSBI mitigation technique presented in (Nezamalhosseni, 2013). The SEB is composed of two branches. At the lower branch, the VC of the selected OFDM signal is selected using an ideal optical filter, named virtual carrier selector (VCS), and then, the VC is removed from the OFDM signal in the up-

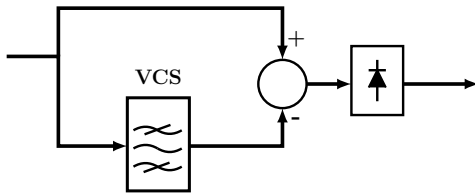

Figure 4: Model of the SEB. VCS stands for VC selector.

per branch. Afterwards, the SSBI is estimated after the photodetection of the OFDM signal without the VC. To conclude the SSBI mitigation algorithm, the SSBI is removed from the photodetected OFDM signal before arriving the OFDM receiver, as shown in Figure 3. In this work, we assume that both branches of the SEB are synchronized.

At the BS input, the OFDM signal,  $s_r(t)$ , impaired by the interferer and ASE noise can be written as

$$s_r(t) = s_0(t) + \sum_{i=1}^{N_x} s_{x,i}(t - \tau_i) e^{j\phi_i} + N_0(t) \quad (1)$$

where  $s_0(t)$  is the selected OFDM signal,  $s_{x,i}(t)$  is the  $i$ -th interfering signal of  $N_x$  interferers and  $N_0(t)$  is the complex envelope of the ASE noise. We assume that, the ASE noise follows a zero mean Gaussian distribution with variance of  $N_0 B_{sim}$ , where  $N_0$  is the ASE noise power spectrum density and  $B_{sim}$  is the bandwidth used in the MC simulation.  $\tau_i$  and  $\phi_i$  are, respectively, the time delay and the phase difference between the selected and the  $i$ -th interfering signals.  $\tau_i$  is modeled as a uniformly distributed random variable between zero and  $T_s$ , and  $\phi_i$  has a uniform distribution within the interval  $[0, 2\pi]$  (Winzer, 2011). The relation between the average powers of the  $i$ -th interferer and the selected OFDM signal is defined as the crosstalk level (Winzer, 2011). In each iteration of the MC simulation, a sample function of ASE noise and of in-band crosstalk are generated and added to the optical OFDM signal.

When estimating the EVM, the MC simulation stops after 75 iterations (Alves, 2010), and then, the root mean square (rms) of the EVM of each OFDM subcarrier is evaluated using (Alves, 2010)

$$EVM_{rms}[k] = \sqrt{\frac{\sum_{n=1}^{N_s} |s_r^n[k] - s_t^n[k]|^2}{\sum_{n=1}^{N_s} |s_t^n[k]|^2}} \quad k \in \{1, 2, \dots, N_{sc}\} \quad (2)$$

where  $s_r^n[k]$  and  $s_t^n[k]$  are, respectively, the received and the transmitted symbol at the  $k$ -th subcarrier of each  $n$ -th OFDM symbol of the total number of generated OFDM symbols,  $N_s$ . Then, the BER of each

subcarrier,  $BER[k]$  is computed from (Shafik, 2006)

$$BER[k] = 4 \frac{(1 - 1/\sqrt{M})}{\log_2(M)} Q \left( \sqrt{\frac{3}{(M-1) \cdot EVM_{rms}[k]^2}} \right) \quad (3)$$

and the overall BER of the OFDM signal is given by

$$BER = \frac{1}{N_{sc}} \sum_{k=1}^{N_{sc}} BER[k] \quad (4)$$

Remark that Equation 3 assumes a Gaussian distribution for the distortion each subcarrier (Alves, 2010).

The BER is estimated from DEC after a total of 5000 counted errors,  $N_e$ , is reached in the OFDM received signal, and is obtained using  $N_e/(N_s N_{it} N_{sc} N_b)$ , where  $N_{it}$  is the number of iterations of the MC simulation and  $N_b$  is the number of bits per symbol in each OFDM subcarrier (Alves, 2010).

### 3 RESULTS AND DISCUSSION

In this section, the tolerance to in-band crosstalk of the VC-assisted DD MB-OFDM communication system is assessed numerically. The tolerated crosstalk level,  $X_{c,max}$ , is defined as the crosstalk level that leads to a 1 dB optical signal-to-noise ratio (OSNR) penalty. The OSNR penalty is defined as the difference in dB between the OSNR in presence of crosstalk and the OSNR without crosstalk that lead to a BER of  $10^{-3}$  (Winzer, 2011).

Table 1 presents the parameters used in MC simulation, in order to assess the tolerance to in-band crosstalk of the VC-assisted DD OFDM system. The VBPR, the  $-3$  dB bandwidth of the BS, which in this work is a  $2^{nd}$ -order Super-Gaussian, and the modulation index are obtained from the optimization performed in (Alves, 2015). The parameters of the selected OFDM signal are kept the same throughout

Table 1: Simulation parameters of the VC-assisted DD OFDM system.

Bit rate per band [Gbps]	10.7
Number of subcarriers ( $N_{sc}$ )	128
Bandwidth [GHz]	2.675
OFDM symbol duration [ns]	47.85
Central frequency [GHz]	5
VBPR [dB]	6
VBG [MHz]	20.9
$-3$ dB bandwidth of BS [GHz]	3.6
modulation index	5%
OSNR @ BER= $10^{-3}$ [dB]	15.3
modulation format	16-QAM

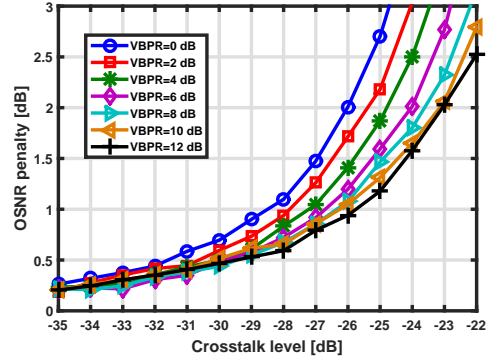

Figure 5: OSNR penalty as a function of the crosstalk level obtained from the EVM method, for interfering signals with different VBPRs.

this work. The parameters of the interferer are equal to the ones of the selected OFDM signal, except for the VBPR and VBG. The OSNR for a BER of  $10^{-3}$  without crosstalk is obtained using the EVM, and is in agreement with the OSNR obtained using DEC.

In subsection 3.1, the VBPR of the interferer is changed and its influence on the VC-assisted DD OFDM system performance is assessed. In subsection 3.2, the impact of the VBG of the interferer on the in-band crosstalk tolerance is evaluated considering two distinct scenarios: in scenario (a), the frequencies of the selected signal and interferer VCs are the same, and in scenario (b) the central frequencies of the OFDM band of the selected signal and interferers are equal.

#### 3.1 Influence of the VBPR on the in-band tolerance

Figure 5 depicts the OSNR penalty as a function of the crosstalk level due to a single interferer having different VBPRs than the selected OFDM signal, obtained using the EVM method. Figure 5 shows that higher VBPRs of the interferer lead to lower OSNR penalties. In Figure 6, the tolerated crosstalk level, obtained from Figure 5, is depicted as a function of the VBPR with a solid line. Figure 6 shows also the tolerated crosstalk level as a function of the VBPR, estimated using DEC, with a dashed line. A difference of about 2.75 dB between the tolerated crosstalk level for VBPR of 0 dB and 12 dB is observed, and the receiver performance degradation enhances with the increase of the VBPR of the interferer. In this case, the interfering band overlaps the selected OFDM band in the frequency domain, and therefore, the increase of the VBPR of the interferer reduces the power of its OFDM band, hence, leading to less interference.

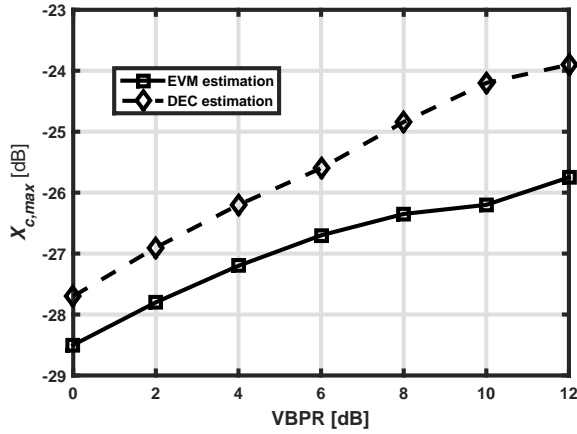
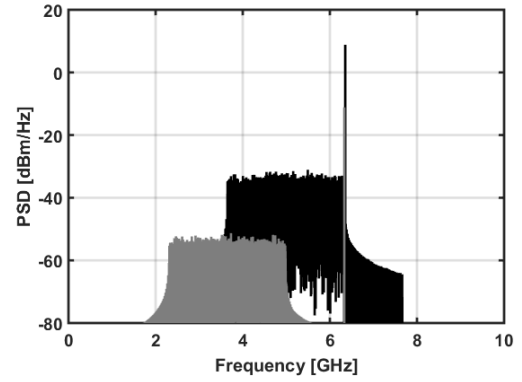

Figure 6: Tolerated crosstalk level as a function of the VBPR of the interferer, considering DEC (dashed lines) and EVM (solid lines) estimations.

The tolerated crosstalk levels obtained using the DEC method are 0.8 to 1.8 dB higher than the ones obtained using EVM method, and the difference is higher with the increase of the VBPR of the interferer. As an example, for a VBPR of 6 dB, the EVM estimates a tolerated crosstalk level of  $-26.7$  dB, while, the DEC predicts a tolerated crosstalk of  $-25.6$  dB. Considering these discrepancies between both methods, we conclude that the EVM is inaccurate on the tolerated crosstalk level estimation, when the selected and interferer OFDM signal have the same VBG but different VBPRs. The in-band crosstalk sample functions are not modelled by a Gaussian distribution, thus, the BER obtained from Equation 3 can lead to poor BER accuracy (Alves, 2010).

### 3.2 Influence of the VBG on the in-band tolerance

In this subsection, the impact of the VBG of the interferer on the VC-assisted DD OFDM system performance is assessed, considering two different scenarios. In scenario (a), the frequency of the VC of the interfering OFDM signal is the same as the VC of the selected signal, and the variation of the VBG of the interferer leads to a frequency deviation between the central frequencies of the selected and interferer OFDM bands, as it can be seen in Figure 7(a). In Figure 7(a), the spectrum of the selected OFDM signal is depicted in black and the interfering OFDM signal spectrum is shown in gray. The interferer has a crosstalk level of  $-20$  dB and a VBG of 1.34 GHz. Figure 7(b) exemplifies the scenario (b), in which, the central frequencies of the interfering and the selected OFDM bands are the same, and the variation of the VBG of the interferer leads to a frequency difference



(a)

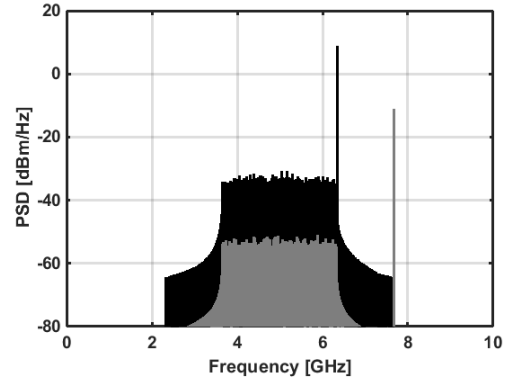

(b)

Figure 7: PSDs of the selected OFDM signal (black) and interferer signal (gray) with a crosstalk level of  $-20$  dB and a  $VBG=B_w/2$  considering (a) same VC frequencies and (b) equal OFDM bands central frequencies.

between the VC frequencies of the selected and interferer signals. In Figure 7(b), the VBG of the interferer is also 1.34 GHz.

Figure 8 depicts the tolerated crosstalk level as a

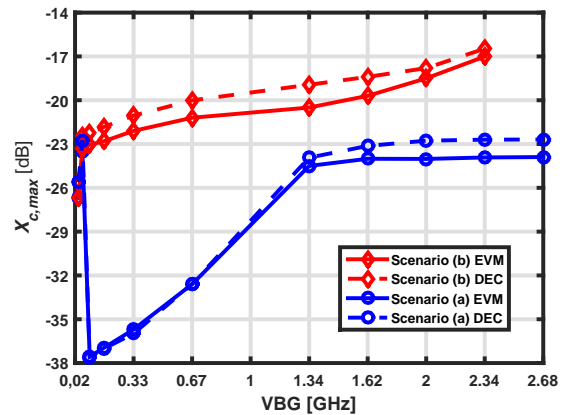

Figure 8: Tolerated crosstalk level as a function of the VBG considering the DEC (dashed lines) and EVM (solid lines) estimations.

function of the VBG of the interferer, for both simulation scenarios. Focusing on scenario (a), Figure 8 shows that the tolerance to in-band crosstalk increases with the VBG of the interferer. The crosstalk level with a VBG of 2.34 GHz is about 9 dB higher than the one obtained with a VBG of 20.9 MHz. As already said, this scenario leads to the misalignment between the central frequencies of the interferer and selected bands, thereby, as the VBG increases, less subcarriers of the selected band are affected by in-band crosstalk, and consequently, the robustness of the DD OFDM system to in-band crosstalk is enhanced. For a VBG of 2.68 GHz, the interferer OFDM band is totally misaligned from the selected signal OFDM band, which means, that the OFDM subcarriers of the selected signal are not affected by in-band crosstalk, leading to a null OSNR penalty. Hence, we can conclude that, in scenario (a), the DD OFDM receiver is completely tolerant to interfering OFDM signals with VBG equal or wider than the selected OFDM signal bandwidth.

Figure 8 shows that the EVM estimations for the tolerated crosstalk level are in disagreement with the DEC estimations, since a difference below 2 dB between both estimations is observed. Once again, this disagreement between the two methods is attributed to the non-Gaussian distribution of the in-band crosstalk sample functions.

Regarding scenario (b), Figure 8 shows that interfering signals with a VBG between 83.6 MHz and 0.67 GHz exhibit a significant reduction on the tolerated crosstalk level, in comparison with smaller VBG. For a VBG of 83.6 MHz, the tolerated crosstalk level is about 11 dB lower than the one obtained for a VBG of 20.9 MHz.

In order to investigate this behavior, the BER estimated using the EVM as a function of the subcarrier index is depicted in Figure 9. In Figure 9, the crosstalk level is set to  $-26$  dB, in order to enable a performance comparison with different VBGs of

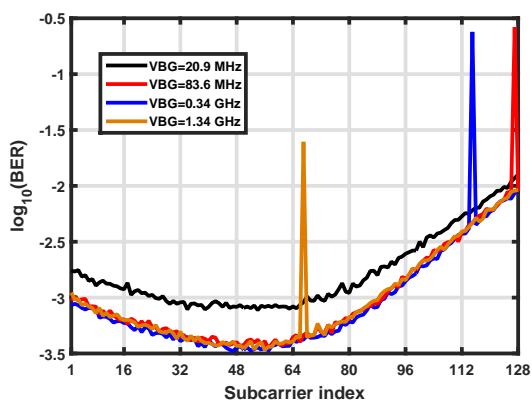

Figure 9: BER as a function of the subcarrier index.

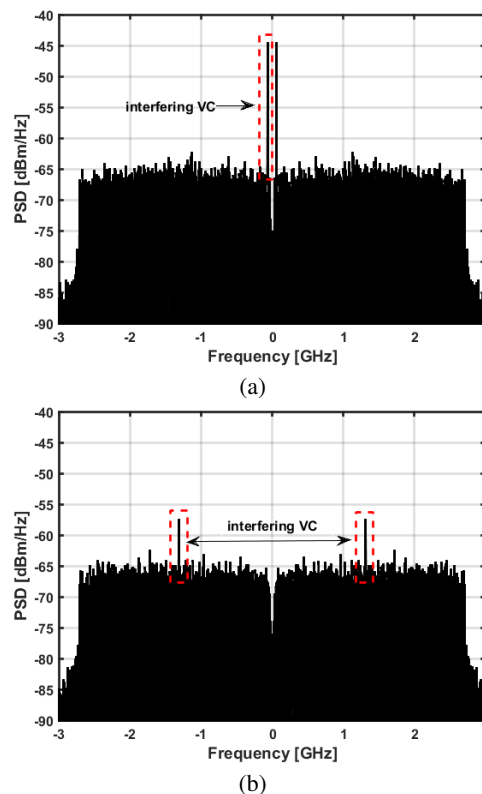

Figure 10: PSDs of the photodetected signal for a crosstalk level of  $-20$  dB and (a) VBG of 83.6 MHz and (b) VBG of 1.34 GHz on the interfering OFDM signal.

the interferer. From Figure 9, it is clear that for a VBG of 83.6 MHz, the subcarrier 128 is the subcarrier with the worst performance due to the presence of the detected VC interferer. The increase of the VBG of the interferer changes the subcarrier with worst performance and the BER per subcarrier is reduced, hence, decreasing the overall BER. It was verified that this effect is due to the BS filtering. As the VBG increases, the frequency of the interferer VC becomes closer to the cut-off region of the BS, hence, the power of the VC is attenuated, and after photodetection, the performance of the subcarrier that suffers the VC interference is improved. For interferers with a VBG of 2.68 GHz, the frequency of interferer VC is outside the BS passband, leading to a fully suppression of the interfering VC. This can be inferred from the comparison of the OFDM signal spectrums at the photodetector output depicted in Figure 10.

Figure 10(a) shows the photodetection of the selected band in presence of an interfering band having a VBG of 83.6 MHz, while, in Figure 10(b), the VBG of the interferer band is 1.34 GHz. By comparing both figures, it is clear that the increase of the VBG leads to a frequency shift of the detected interferer VC and

to an attenuation of its power.

Comparing the tolerated crosstalk levels estimated from both methods, in scenario (b), Figure 8 shows that, for interferers with VBGs between 83.6 MHz and 0.67 GHz, the tolerated crosstalk level estimations obtained from EVM and DEC are in agreement. For the remaining VBGs, in which higher tolerated crosstalk levels are estimated, a maximum difference of 1.2 dB between both estimations is noticed. Hence, we can conclude that the increase of the tolerated crosstalk level leads to discrepancies between the EVM and the DEC estimations, as the BER estimated from EVM, using Equation 3, loses accuracy.

## 4 CONCLUSIONS

In this work, the tolerance to in-band crosstalk of the VC-assisted DD MB-OFDM system has been assessed numerically. The influence of the VBPR and VBG of the interferer on the in-band crosstalk tolerance has been analyzed.

Our results show that the impact of in-band crosstalk on the DD OFDM system performance diminishes with the increase of the VBPR of the interferer. The increase of the power of the interferer VC leads to a power reduction of the interferer OFDM band, hence, causing less interference on the selected signal.

The influence of the VBG of the interfering signal on the in-band tolerance has been evaluated considering two different scenarios. In scenario (a), the frequency of the VCs of the selected signal and interferer are equal. In this case, the tolerance to in-band crosstalk reduces with the amount of superposition of interferer and selected OFDM bands. Larger VBG leads to a reduction of the number of subcarriers that are affected by crosstalk and the system performance improves. When the VBG is equal to the OFDM signal bandwidth, the in-band crosstalk has no influence on the DD OFDM receiver performance degradation.

In scenario (b), the central frequencies of the selected signal and interferer bands are equal. In this case, the tolerance to in-band crosstalk is severely diminished for a VBG of 83.6 MHz, leading to a tolerated crosstalk level that is about 11 dB lower than the ones obtained for very narrow VBGs. This effect is due to the detection of the interferer VC on the selected signal and leads to a strong performance degradation. As the VBG of the interferer becomes larger, the BS filtering reduces the power of the VC of the interferer and the performance of the DD OFDM receiver is improved.

The comparison between the numerical results ob-

tained from the DEC and EVM methods shows that, for higher crosstalk levels, a maximum difference of 2 dB between both methods estimations has been noticed. When the tolerated crosstalk level is lower than  $-30$  dB, the EVM and the DEC estimations are in agreement. Hence, we can conclude that higher crosstalk levels lead to an inaccurate BER estimations.

## ACKNOWLEDGMENTS

This work was supported by Fundação para a Ciência e Tecnologia (FCT) from Portugal through Project MORFEUS-PTDC/EEITEL/2573/2012. The project UID/EEA/50008/2013 is also acknowledged.

## REFERENCES

- Alves, T., Alberto, A., and Cartaxo, A. (2014). Direct-Detection Multi-Band OFDM Metro Networks Employing Virtual Carriers and Low Receiver Bandwidth. *Opt. Fiber Commun. Conf.*
- Alves, T. and Cartaxo, A. (2015). High Granularity Multi-band OFDM Virtual Carrier-assisted Direct-Detection Metro Networks. 33(1):42–54, paper Tu3G.5.
- Alves, T. and Cartaxo, A. (2010). Analysis of Methods of Performance Evaluation of Direct-Detection OFDM Communication Systems. *Fiber and Integrated Optics*, 29(3):170 – 186.
- Nezamalhosseini, S., Chen, L., Zhuge, Q., Malekiha, M., Marvasti, F., and Plant, D. (2013). Theoretical and Experimental Investigation of Direct Detection Optical OFDM Transmission using Beat Interference Cancellation Receiver. *Opt. Express*, 21(13):15237–15246.
- Peng, W., Zhang, B., Feng, K., Wu, X., Willner, A., and Chi, S. (2009). Spectrally Efficient Direct-Detected OFDM Transmission Incorporating a Tunable Frequency Gap and an Iterative Detection Techniques. *J. Light. Technol.*, 27(24):5723–5735.
- Rebola, J. and Cartaxo, A. (2014). Impact of In-Band Crosstalk Due to Mixed Modulation Formats with Multiple Line Rates on Direct-Detection OFDM Optical Networks Performance. In *Int. Conf. Transparent Opt. Networks*, pages 14–17.
- Shafik, R., Rahman, S., and Islam, R. (2006). On the Extended Relationships Among EVM, BER and SNR as Performance Metrics. In *International Conference on Electrical and Computer Engineering (ICECE)*, pages 408–411.
- Winzer, P., Gnauck, A., Konczykowska, A., Jorge, F., and Dupuy, J. (2011). Penalties from In-Band Crosstalk for Advanced Optical Modulation Formats. In *European Conference and Exhibition on Optical Communication (ECOC)*, paper Tu.5.B.7.